

Finapp User Manual

User Manual

Date of Revision: 14/04/2025

Date of First Issue: 22/01/2024

Mod.	M013
Rev.	20231129

Scope

User manual intended for the customer describing the probe, how to install it, and how to have access to the data via the Finapp Cloud.

Disclaimer

No part of this manual may be reproduced in any form or by any means, electronic, mechanical, recording, or otherwise, without the prior written permission of FINAPP srl.

FINAPP will repair or replace any product within the guarantee period if the Guarantor declares that the product is defective due to workmanship or materials and has not been caused by mishandling, negligence on behalf of the User, accident or any abnormal conditions or operations.

FINAPP declines all responsibility for damages or injuries caused by an improper use of the probe due to negligence on behalf of the User. It is strongly recommended to read thoroughly the FINAPP User's Manual before any kind of operation.

FINAPP reserves the right to change partially or entirely the contents of this Manual at any time and without giving any notice.

Disposal of the Product The product must never be dumped in the Municipal Waste. Please check your local regulations for disposal of electronics products.

Table of contents

- 1. Introduction..... 5**
- 2. Description of the Finapp Probe 7**
 - 2.1 Detector.....7
 - Finapp neutron detector.....7
 - Neutron capture.....7
 - 2.2 Electronic Boards..... 8
 - Master Board Block Diagram 10
 - Master Board Technical specifications 10
 - Master Board Pinout..... 11
 - PMT Board Block Diagram..... 13
 - PMT Board Technical specifications..... 13
 - PMT Board Pinout..... 14
 - 2.3 Master Board Accessories..... 14
- 3. Installation types 14**
 - 3.1 Finapp Soil Moisture (SM) 15
 - 3.2 Finapp Snow Water Equivalent (SWE)..... 16
- 4. Package Content..... 17**
- 5. Finapp-SM Installation Guide..... 20**
 - 5.1 Install the pole 21
 - 5.2 Mount the Finapp probe on the pole 21
 - 5.3 Mount the solar panel..... 22
 - 5.4 Insert solar panel cable..... 23
 - 5.5 Connect temperature sensor (optional)..... 24
 - 5.6 Insert the battery 24
 - 5.7 Connect battery and solar panel 25
 - 5.8 Switch ON the system 25
- 6. Finapp-SWE Installation Guide 26**
 - 6.1 Probe on the pole..... 26

6.2 Probe on the ground.....	26
7. Deinstallation	29
7.1 Safe power-off.....	29
7.2 Remove cables.....	29
7.3 Remove battery.....	29
7.4 Dismount hardware from the pole (and ground).....	29
8. Finapp Cloud Platform	29
8.1 Access the Finapp Dashboard.....	29
8.2 Finapp Dashboard Configuration.....	31
8.3 Data visualization	33
8.4 Status control panel.....	34
9. Data transfer	35
9.1 Download data from API.....	35
9.2 Retrieve data on SD Card.....	37
9.3 GPS data.....	37
10. External Modules	39
10.1 SDI-12.....	39
SDI12 module connection.....	40
SDI12 data retrieval	41
Master Information.....	41
Finapp sensor Information	42
Elaborated Data	43

1. Introduction

The Finapp probe is a CRNS – cosmic ray neutron sensing – probe that measures soil moisture down to 50 cm and SWE – snow water equivalent.

The values are referred to an area around the probe of about 100-300m of radius depending on the altitude, the higher the longer.

Since neutrons are naturally moderated by water molecules, CRNS probes can relate the counting of cosmic ray neutrons with the water content of soil and of the snow. A decrease in the neutron counting is related to an increase of water content. Thanks to the innovative materials and design of Finapp probes it is also possible to monitor the incoming cosmic-ray flux variations. Temperature and barometric pressure are also measured, due to determine the total incoming in the most precise way. This allows a real time, in situ validation of water content. This specific feature is a unique on the market and is part of our patent.

A data acquisition board developed by Finapp is also included. Data telemetry is accomplished via a GSM modem and locally stored on a SD card. Furthermore, the probe can communicate through SDI12 protocol. The neutron detector, data logger unit and weather sensors are housed in an IP-67 enclosure for outdoor use.

Finapp probe has a self-checking system that allows to detect probe malfunctions and a specific algorithm for converting neutron counting into soil moisture and SWE according with customer needs.

WARNING: Do not modify this product without first contacting Finapp SRL. Unauthorized modifications can damage the product and invalidate warranty.

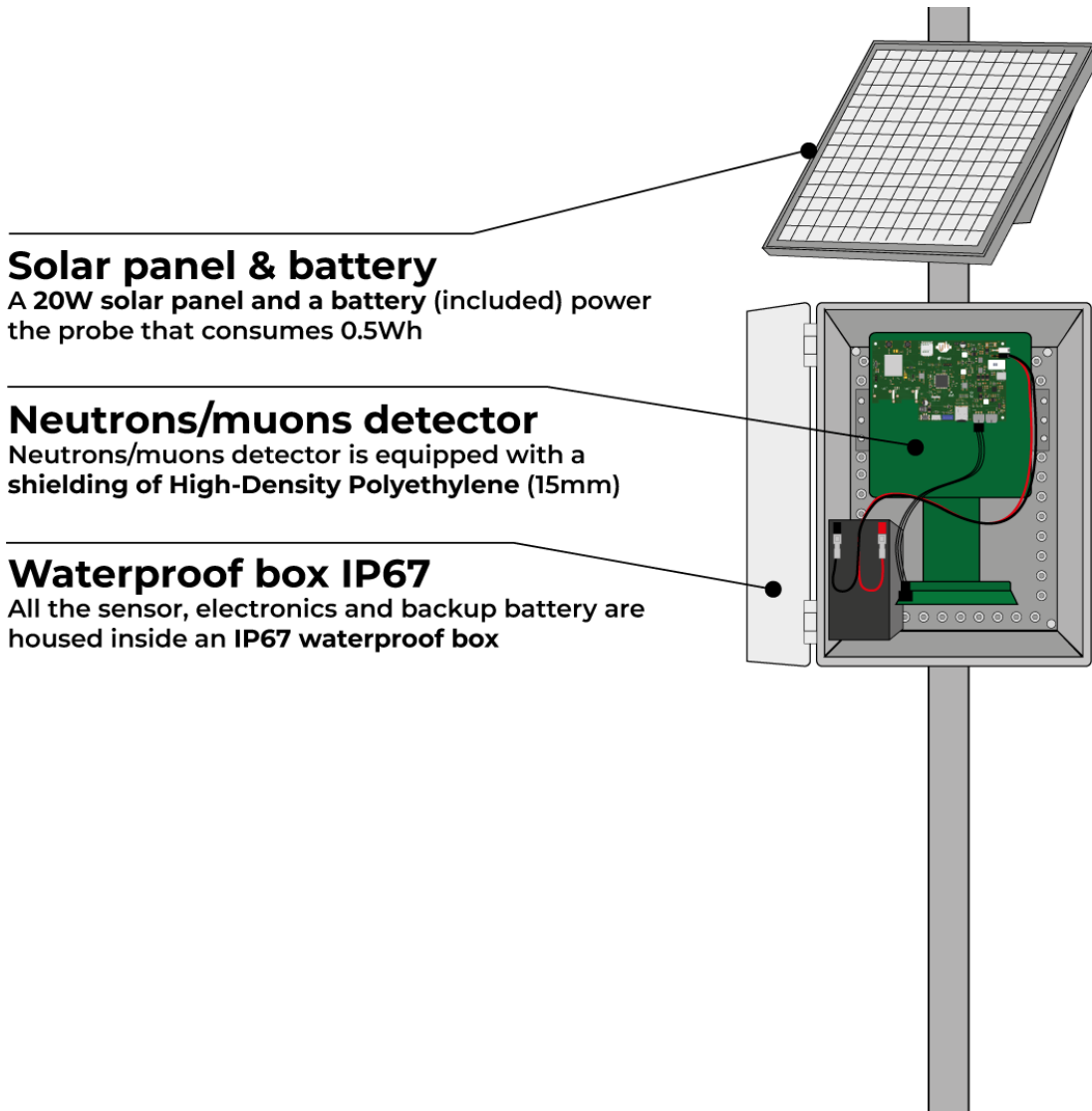

Solar panel & battery

A 20W solar panel and a battery (included) power the probe that consumes 0.5Wh

Neutrons/muons detector

Neutrons/muons detector is equipped with a shielding of High-Density Polyethylene (15mm)

Waterproof box IP67

All the sensor, electronics and backup battery are housed inside an IP67 waterproof box

Figure 1: Description of the main characteristics of the Finapp

2. Description of the Probe

2.1 Detector

The detector is a compact system able to detect thermal neutrons in an efficient way with low sensitivity to gamma radiation. The detector is protected by a 15 mm high-density polyethylene cover to enhance the sensitivity to epithermal neutrons, more correlated with water.

Neutron detector

The detector consists in a layered structure of sheets sensible to thermal neutron and wavelength shifters (WLS) to collect light through the photomultiplier. The thin sheet able to detect thermal neutron consists of a homogeneous matrix of fine particles of stable (no dangerous or explosive) lithium- 6-fluoride (${}^6\text{LiF}$) and zinc sulfide phosphor (ZnS:Ag) compactly dispersed in a colorless silicon binder. The lithium is enriched in ${}^6\text{Li}$ to a minimum of 95 atom percent.

Neutron capture

The neutron detection process employs the nuclear reaction ${}^6\text{Li} (n, \alpha) {}^3\text{H}$:

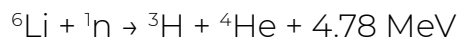

with a cross section of 941 barns for 0.025 eV neutrons. The resulting triton and alpha particle are detected by ZnS:Ag phosphor.

Thermal neutron detector sheet	
${}^6\text{LiF}$:ZnS Mass Ratio	1:3
Thickness	400 μm
Theoretical efficiency	0.25
Light Output (% Anthracene)	300
Wavelength of Maximum Emission	450 nm

The (ZnS:Ag) layer is a scintillator able to detect also muons and electrons. Discrimination between neutron and muons is made by a Pulse Shape Discrimination algorithm covered by a Finapp Patent. The readout of the detector is made with a Head-on Photomultiplier.

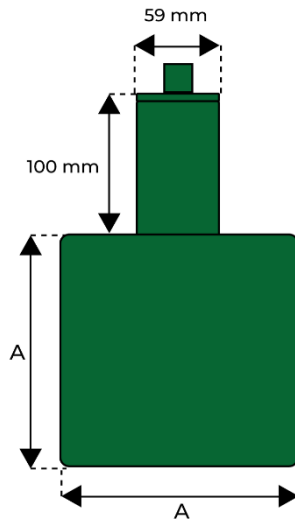

Figure 2: Detector and Photomultiplier

The detector has three hardware models that differs in dimensions of the scintillator and the number of neutrons and muons counts.

Probe	Neutrons ¹	Muons ¹	Size A (cm)
F3	900	4000	20
F5	1800	8000	24
F6	3000	12000	31
FM3	-	5000	17

Counts per hour, at sea level with a soil moisture <5% and a cutoff rigidity of 5GeV

2.2 Electronic Boards

The electronic board is a compact data acquisition board for signal processing designed specifically for Finapp probes. It includes the readout for multiple photomultiplier tubes with digital signal sampling, noise rejection algorithm, power supply, LTE connection (that **contributes to only < 2% of the total power consumption**), GPS localization and common interfaces (UART, SDI-12) to connect the board to existing datalogger. The board is “ultra-low power” for a detector readout with a total power consumption of 30 mA at 12Volt. The SIM card installed by default is 1NCE, but it can be changed according to customer's requirements. If you need to use another SIM please contact Finapp.

The acquisition system is made of two boards: the Master that manage acquisition and data transfer and the PMT board that acquires data from the detector.

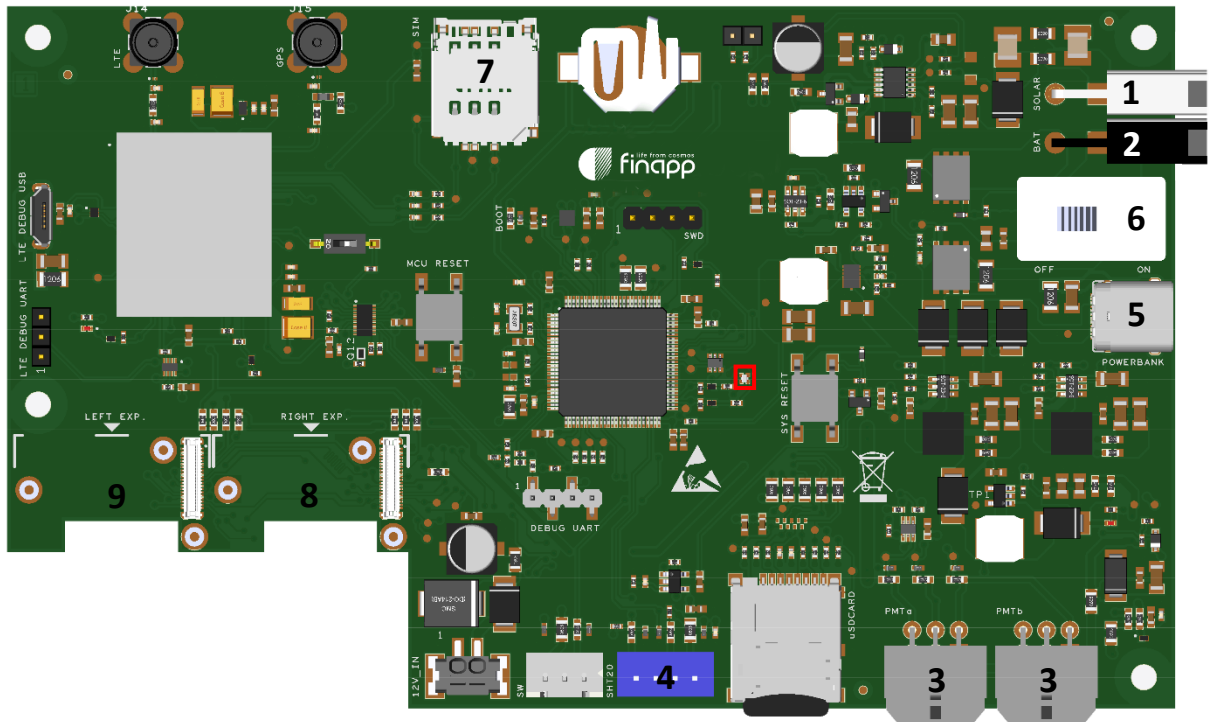

Figure 3: Details of the Master board. 1 - MOLEX of solar panel, 2 - MOLEX of the battery, 3 - PMT connectors, 4 - SHT20, red square – LED for debug, 5 - USB-C for indoor use, 6 – Switch, 7 – SIM card slot, 8 – Expansion slot 1 for RAK external modules, 9 – Expansion slot 2 for RAK external modules

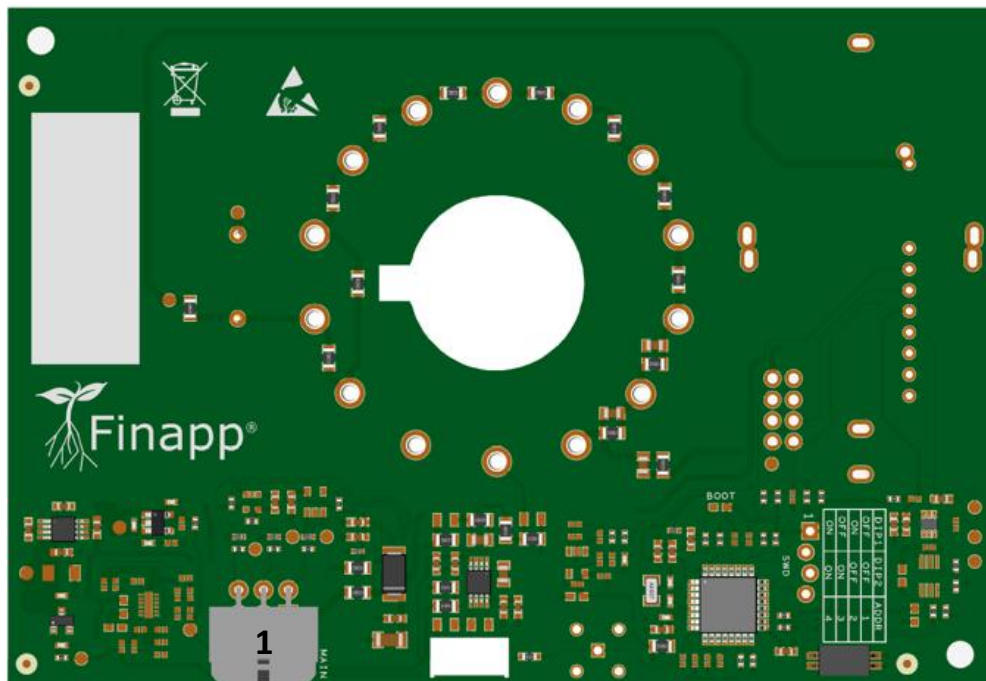
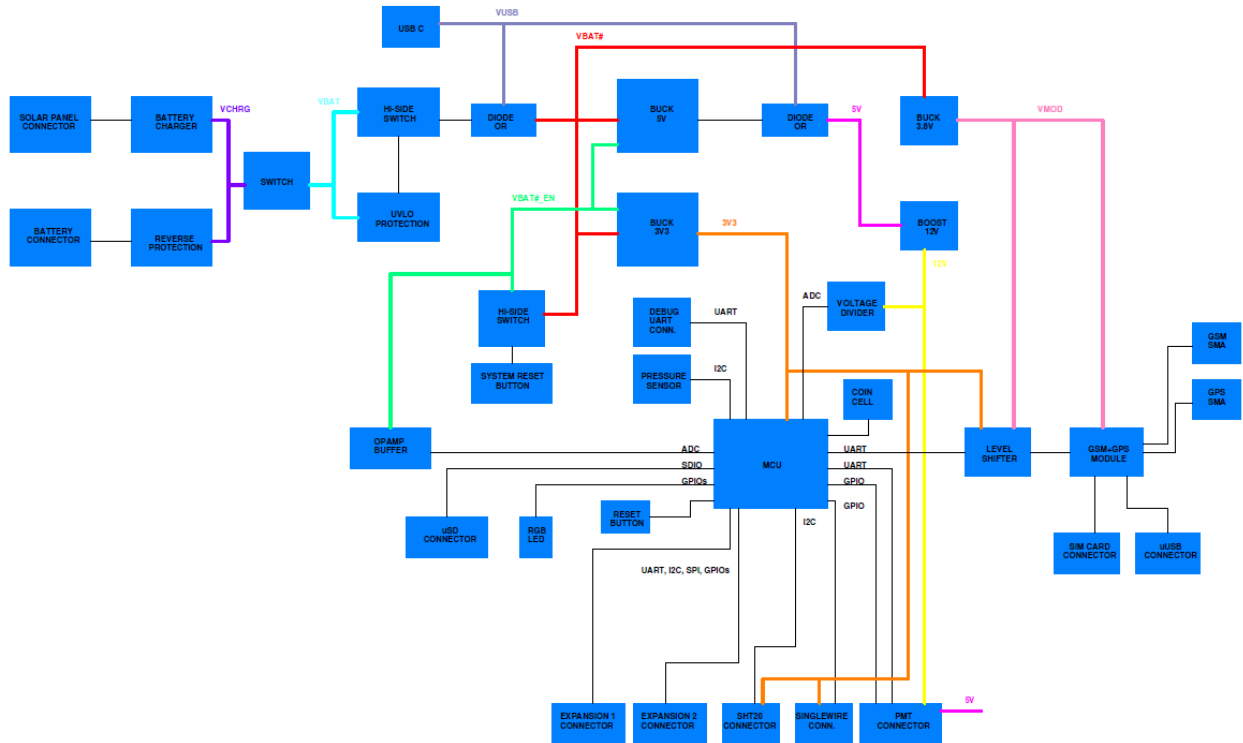

Figure 4: Details of the PMT board. 1 – Master connector

Master Board Block Diagram



Master Board Technical specifications

Description	Symbols	Min	Typ	Max	Units
General					
Power Supply Voltage from Solar Panel	V_{IN_SOLAR}	17.1	-	30	V
Supply Voltage from Lead-Acid Battery	V_{IN_BAT}	11.5	12	15	V
Supply Voltage from SDI-12 interface	V_{IN_SDI12}	11.5	12	13	V
Average current consumption SM	I_{CC}	-	60	-	mA
Average current consumption SWE	I_{CC}	-	110	-	mA
Peak current consumption during battery operation	$I_{CC_PK_BAT}$	-	-	1.22	A
Operating temperature	T_{AMB}	-40	-	85	°C
Power supply output PMT					
Output Voltage #1	V_{12V}		12		V
Output Current #1	I_{12V}	-	-	0.2	A
Output Voltage #2	V_{3V3}		3.3		V
Output Current #2	I_{3V3}	-	-	0.5	A
UART					

<i>Data Rate</i>	D_{R_DBG}	-	115.2	-	kbps
<i>Operating Voltage Range</i>		0	-	V_{3V3}^*	V
Additional features					
<i>Dimension</i>		9 x 15		mm	
<i>Battery Power Protections</i>		Inversion, Overdischarge			
<i>Solar Panel Power Protections</i>		Inversion, Transient overvoltages (surge, burst)			
<i>External Memory</i>		Micro SD Card (Up to 32Gb)			
<i>RTC backup battery</i>		Battery CR1220			
<i>Buttons</i>		Reset			
<i>Signaling LEDs</i>		2x RGB LED			

Master Board Pinout

Solar Panel Connector

MPN Connector: 172448-0002

PIN #	Name	Type	Description
1	GND	POWER	Mass Reference
2	VIN_SOLAR	POWER	Solar panel power input

Battery Connector

MPN Connector: 172448-0002

PIN #	Name	Type	Description
1	GND	POWER	Mass Reference
2	VIN_BAT	POWER	Lead-acid battery power input

PMT Connector

MPN Connector: 1792892

PIN #	Name	Type	Description
1	12V	POWER	Power output 12V
2	3V3	POWER	Power output 3.3V
3	GND	POWER	Mass reference
4	MASTER_TX	DIGITAL OUT	Trasmission line MASTER board
5	MASTER_RX	DIGITAL IN	Receiver line MASTER board
6	PMT_nRST	DIGITAL OUT	Reset Signal for MCU of PMT board

SHT20 Connector

MPN Connettor: B4B-XH-A(LF)(SN)

PIN #	Name	Type	Description
1	3V3	POWER	Output powe 3.3V
2	SCL	DIGITAL OUT	Clock output I2C
3	GND	POWER	Mass reference
4	SDA	DIGITAL BI	Data line I2C

Singlewire Connector

MPN Connettor: B3B-XH-A(LF)(SN)

PIN #	Name	Type	Description
1	3V3	POWER	Power output 3.3V
2	SW_DATA	DIGITAL BI	Transmission and receiver line Singlewire.
3	GND	POWER	Mass reference

UART Connector

MPN Connetto: 10129380-904002ALF

PIN #	Nome	Tipo	Descrizione
1	3V3	POWER	3.3V power supply output
2	DBG_TX	DIGITAL OUT	Serial transmission line for Debug
3	DBG_RX	DIGITAL IN	Serial transmission line for Debug
4	GND	POWER	Mass reference

PMT Board Block Diagram

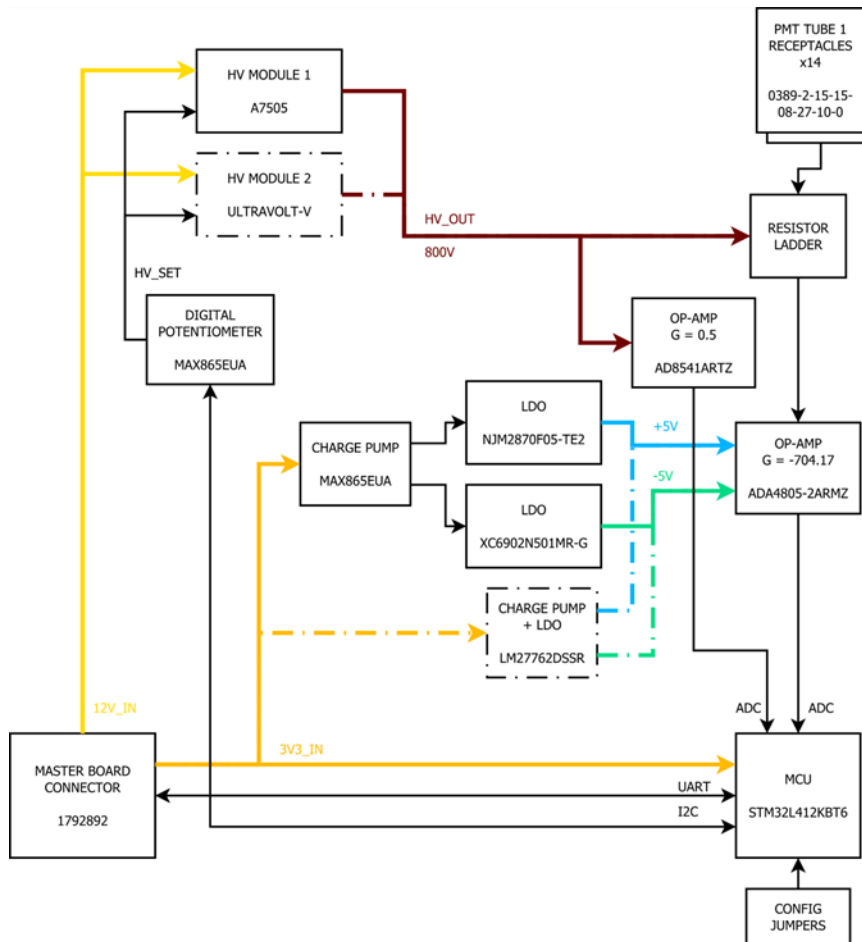

PMT Board Technical specifications

Description	Symbols	Min.	Typ	Max	Unit
General					
<i>HV module supply voltage</i>	V_{12V_IN}	10.8	12	13.2	V
<i>Logic Supply Voltage</i>	V_{3V3_IN}	3	3.3	3.6	V
<i>Current consumption HV module</i>	I_{CC_12V}	-	-	25	mA
<i>Current consumption Logic</i>	I_{CC_3V3}	-	-	25	mA
<i>Operating temperature</i>	T_{AMB}	-40	-	85	°C
MCU					
<i>Core</i>		ARM Cortex-M4 32bit			
<i>Clock Frequency</i>	F_{CORE}	-	-	80	MHz

SRAM		40			kB
Internal Flash		128			kB
MASTER UART					
Data Rate	D_{R_ETH}	-	115.2	-	kbps
Operating voltage range		0	-	V_{3V3}*	V
Additional features					
Dimension	90x110 mm				
Power protections	Transient overvoltages (surge, burst)				

PMT Board Pinout

Master Board Connector

MPN Connector: 1792892

PIN #	Name	Type	Description
1	12V	POWER	Power input 12V
2	3V3	POWER	Power input 3.3V
3	GND	POWER	Mass reference
4	MASTER_TX	DIGITAL IN	Master trasmission line
5	MASTER_RX	DIGITAL OUT	Master receiver line
6	PMT_nRST	DIGITAL OUT	Reset MCU

2.3 Master Board Accessories

The main board is equipped with:

- 3 V battery
- SD card
- 4G antenna
- 1NCE SIM card

The SIM card can be changed according to customer's requirements. In case you would like to use another SIM card, please contact Finapp.

3. Applications

Finapp probes, according with the model, can measure:

- Soil Moisture - SM
- Snow Water Equivalent - SWE

The operating principle is the same: the neutrons generated by cosmic rays are naturally moderated by the water molecules and more precisely by the hydrogen contained in them. The difference in count between the "fast" neutrons arriving from space and the "slow" ones that have already interacted with the water molecules allows us to have a reliable measurement of Soil Moisture and SWE. The type of probe is also the same for both applications, what changes is the number of probes used and their arrangement.

3.1 Finapp Soil Moisture (Finapp-SM)

The probe measures soil moisture in real time. The probe is installed on a pole, typically 1.8m high, and it covers a radius of about 125m (5ha) in standard conditions¹, for a 0-50cm depth.

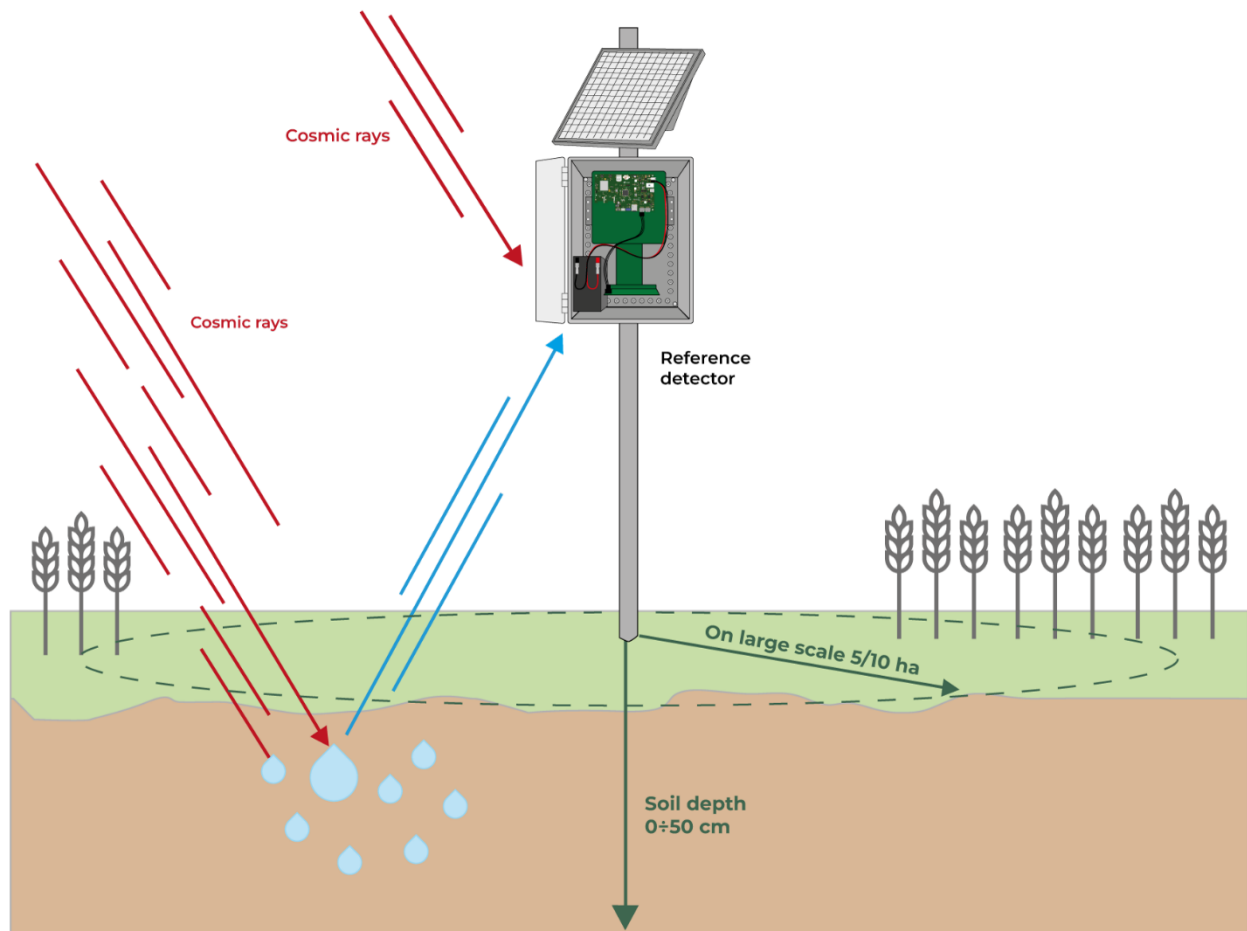

Figure 5: Finapp Soil Moisture installation

¹* at sea level, with a cutoff rigidity of... And soil moisture values of 5%

In this configuration a single probe can count both the fast neutrons arriving from space and the slow neutrons that escape from the ground after being partly absorbed by water molecules. The measurement of soil moisture is understood as the average value over a surface area of approximately 5 hectares, but this value increases with altitude (approximately 10 hectares at 1,000m above sea level) while the depth depends on the water content: the drier the soil, the deeper the neutrons will be able to penetrate.

3.2 Finapp Snow Water Equivalent (SWE-Finapp)

Two probes measure SWE - snow water equivalent - in real time, over a surface of radius about 20m, with a saturation limit up to more than 10'000 mm water equivalent.

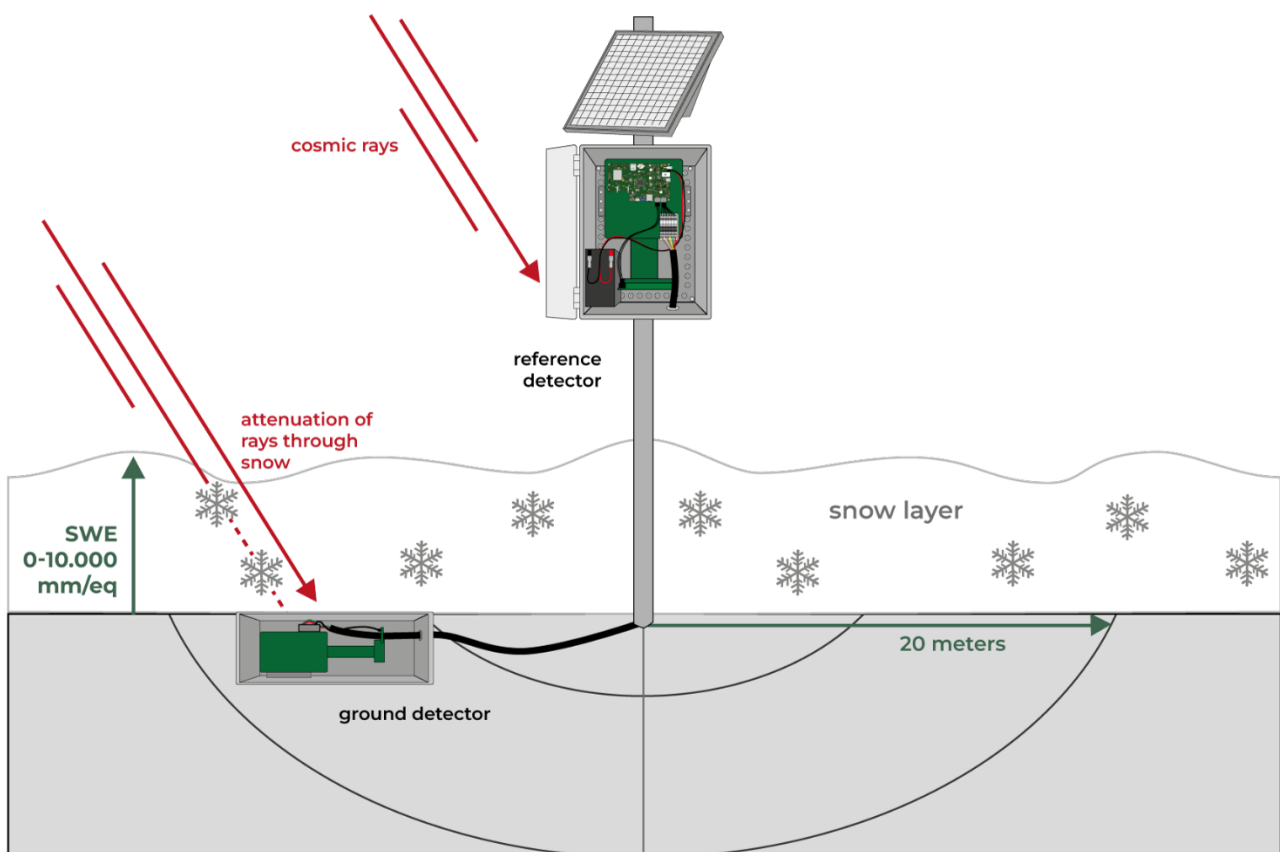

Figure 6: Finapp Snow Water Equivalent installation

In this configuration two probes are used. The first is positioned on the ground or slightly buried and has the purpose of counting how many slow neutrons reach

the ground, after having absorbed by the snowpack above it. The second probe is mounted on a pole and must be always above the snowpack: it has the purpose of providing the "reference number" of the fast neutrons before they interact with the snow cover. The two probes are cable connected to each other.

4. Package Content

The package contains:

- IP67 box containing the neutron probe, electronic boards, PMT board and cable for boards connection.

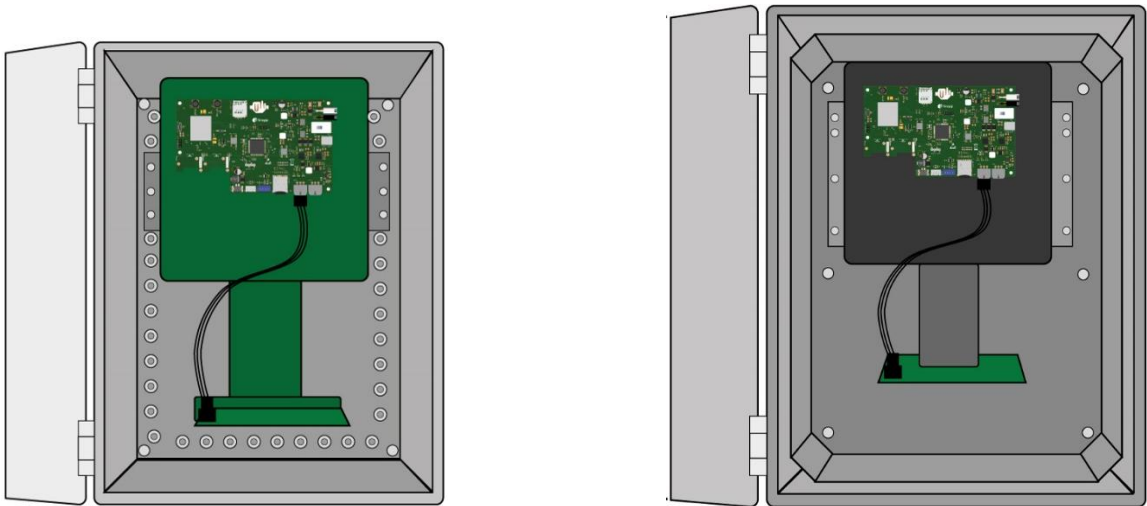

Figure 7: Detector F3 (left) and Detector F5 (right)

- 9Ah lead sealed battery (left) or 18Ah lead sealed battery (right) and battery cable

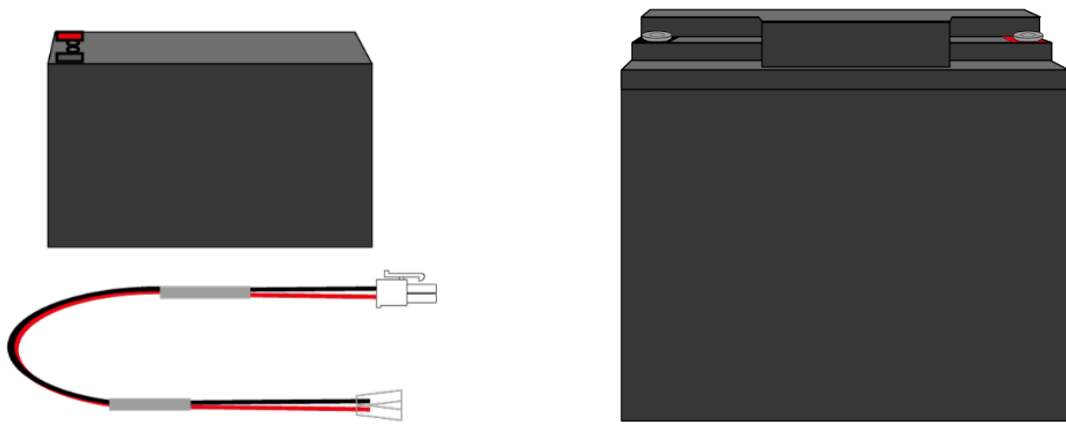

Figure 8: 9 Ah battery (left), 18 Ah battery (right) and battery cable

- 20W solar panel with cables and the bracket for pole mounting

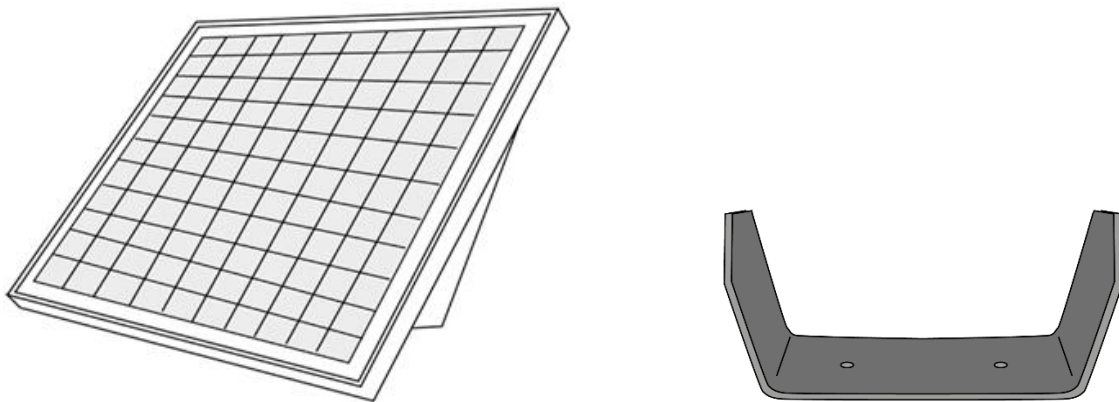

Figure 9: Solar panel (left) and the bracket for pole mounting (right)

- 2 x brackets, 4 x M6x16 screws, 4 x M6x16 flange nuts

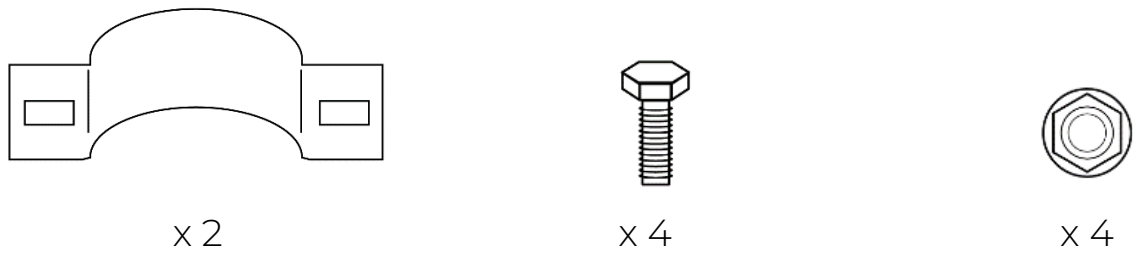

Figure 10: From left to right, brackets, M6x16 screw, M6 flange nut

For Finapp-SWE installation the package will also contain:

- Aluminum box containing a second probe

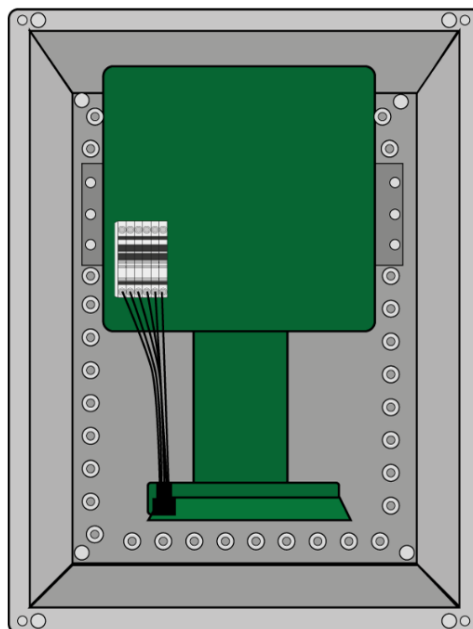

Figure 11: Aluminum box containing a F3

- 15 meters 6-pin cable to connect the two probes

5. Finapp-SM Installation Guide

The system is preconfigured and “plug and play”. The customer needs only to mount the system on a pole with the metal ware provided and connect battery and solar panel. Normally the probe is installed 1.8 meters above the ground to cover an area of radius of 100-120 meters at sea level. The height respect to the ground is defined respect to center of the box. By default, the system is equipped with collar for a 48mm pole mounting, on request it is possible to equip the system for mounting on a diameter between 30 and 90 mm.

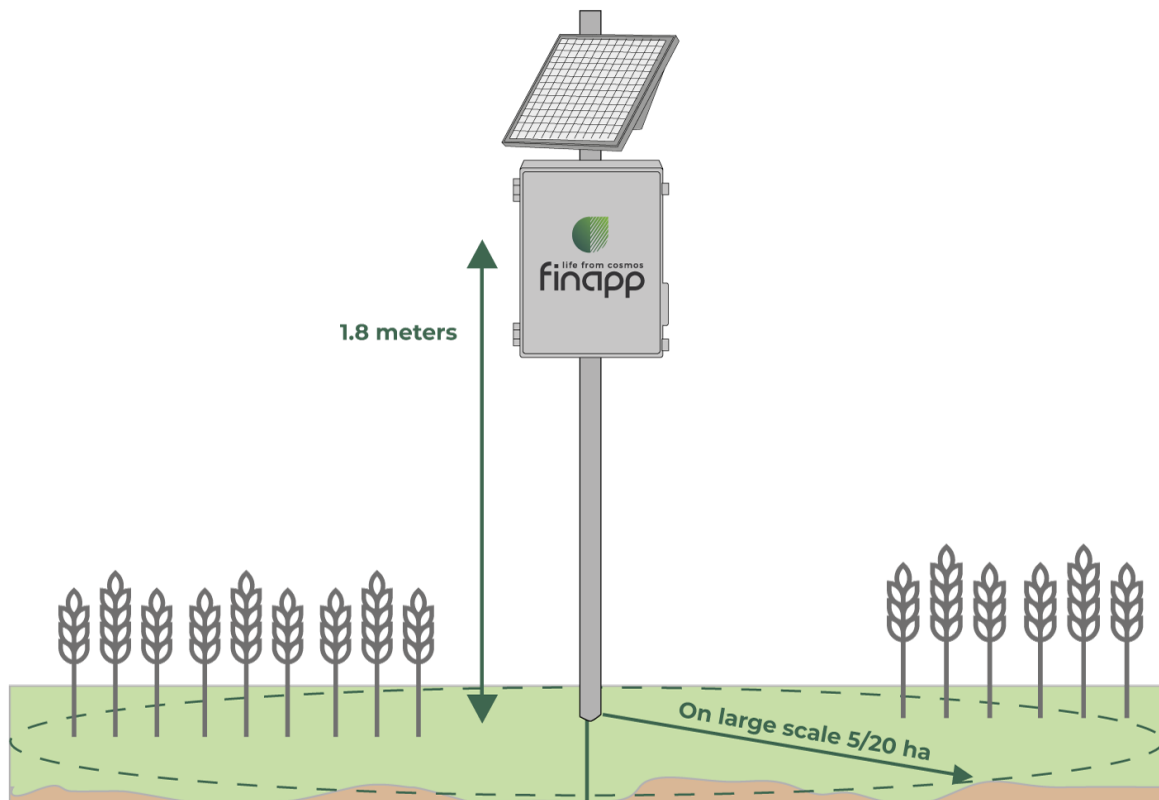

Figure 11: Default height of installation

Proceed as follow:

5.1 Install the pole

If no structure is available in the desired position of installation, it is suggested to mount the system on 2.5 m long, 48 mm section, galvanized iron pole inserted to the ground for 0.5 m to guarantee stability. A screw foundation of 80 cm can be also considered. To insert the screw, create a T shaped structure (Fig.12) with two tubes (with diameter less of the foundation screw) joined with a 90° angle using a clamp tube. The lever structure created will enable twisting and applying force downward to screw the foundation into the soil. Only 10-15 cm of the foundation need to stay out to insert and tight the 2,5 m pole creating a robust installation.



Figure 12: installation of the screw foundation

5.2 Mount the Finapp probe on the pole

The IP67 box containing the detector and master board is provided with aluminum bars in the rear for pole mounting. Attach the top and bottom collars using two M6 screws to fix the collar (Fig.13). Collars and bolts are provided within the metal ware. Attach the probe to the pole end close the collars firmly to prevent any movements.

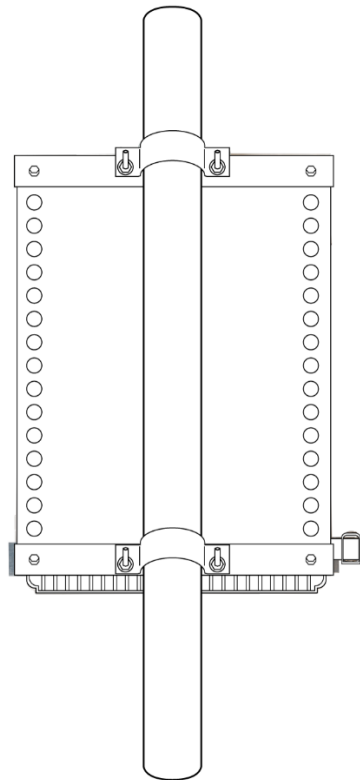

Figure 13: Mounting bars for Finapp box

5.3 Mount the solar panel

The solar panel structure can be assembled by installing the U-shaped bracket (1) to the horizontal bars of the solar panel as shown (Fig.14). Attach the collar to the U-shaped bracket and mount the solar finalized panel structure with provided screws. The inclination of the solar panel is adjustable. Taking the vertical axis as a reference, it is possible to choose a 30° angle (recommended in snowy areas or for high latitude installations), a 45° angle (recommended for mid-latitudes), and a 60° angle (recommended for the tropical zone). The solar panel must be facing towards south direction to guarantee the maximum recharge of the backup battery during daylight. Firmly close the collar especially in windy areas to prevent changes in direction of the solar panel.

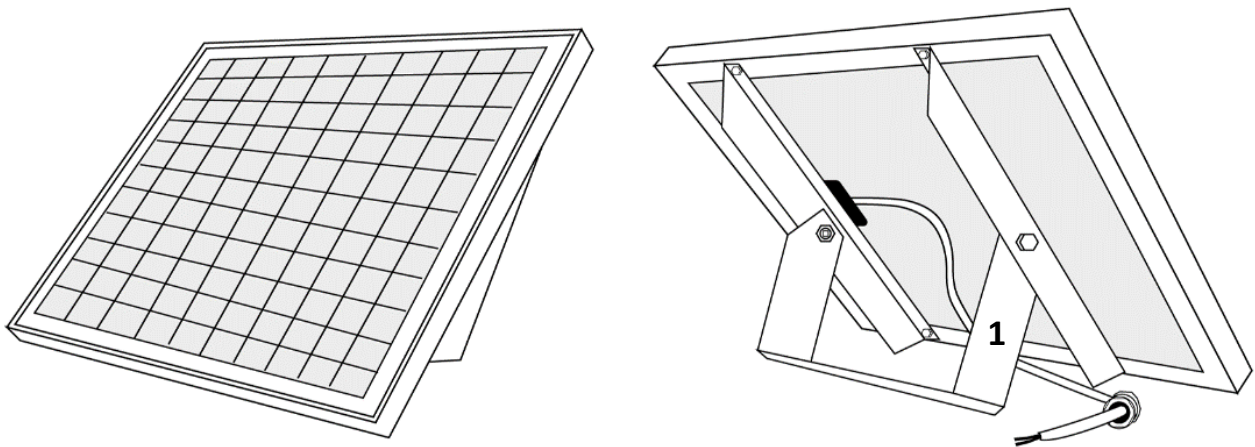

Figure 14: Mounting brackets for solar panel

5.4 Inserting pre-wired cables

On the bottom of the box there is/are pre-drilled hole/s to Insert the pre-wired cables with cable gland. Follow the steps in figure 15 to insert each cable in the bottom of the Finapp box. Firmly close the cable gland to prevent the entrance of humidity inside the box.

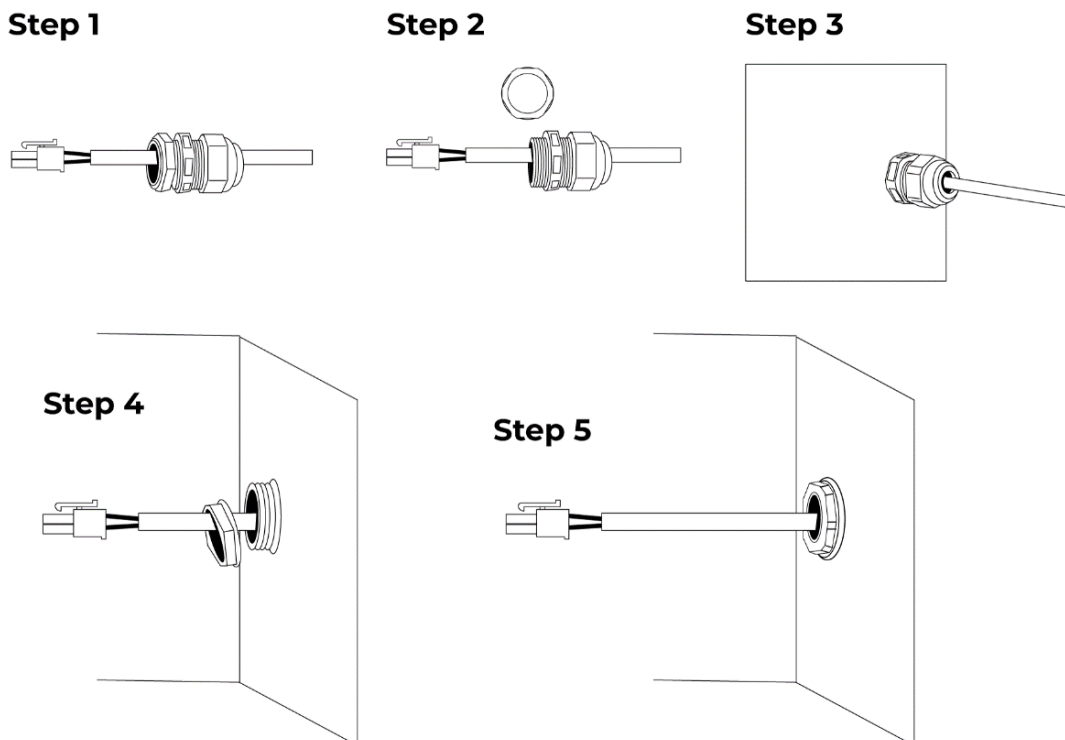

Figure 15: Steps for inserting pre-wired cable into Finapp box

5.5 Connect external temperature-humidity sensor (optional)

An external temperature - humidity sensor is provided inside a solar shield. You can connect it to the main board in the SHT20 connector (connector 4, figure 3). Remember to connect the temperature - humidity sensor before powering on the system. To insert the cable inside the box, follow chapter 5.4.

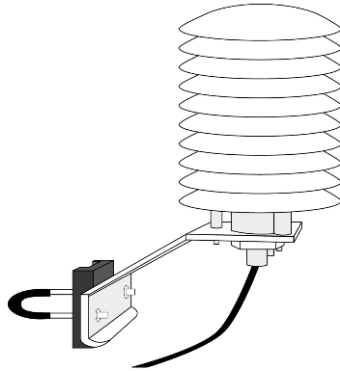

Figure 16: Solar shield with temperature sensor inside

5.6 Insert the battery

These are the types of batteries are used:

for Soil Moisture - SM:

Ah	Voltage (V)	Weight (kg)	Durability (without solar panel)
9	12	2.1	5.5 days
14	12	4.4	11 days
18	12	5.5	14 days

for Snow Water Equivalent - SWE:

Ah	Voltage (V)	Weight (kg)	Durability (without solar panel)
18	12	5.5	7 days
50	12	11.5	29 days
100	12	12.5	58 days

In case you need a battery with longer battery life, Finapp will make a custom solution according to your request.

The battery should be placed in the bottom of the box and connected to the battery cable provided by Finapp as show in figure 17.

If the batteries, for space reasons, cannot be placed in the normal up position, they can be placed lying horizontally/vertically as they are hermetically sealed.

NOTE: In case you are powering the board through an external data logger, DO NOT use the battery.

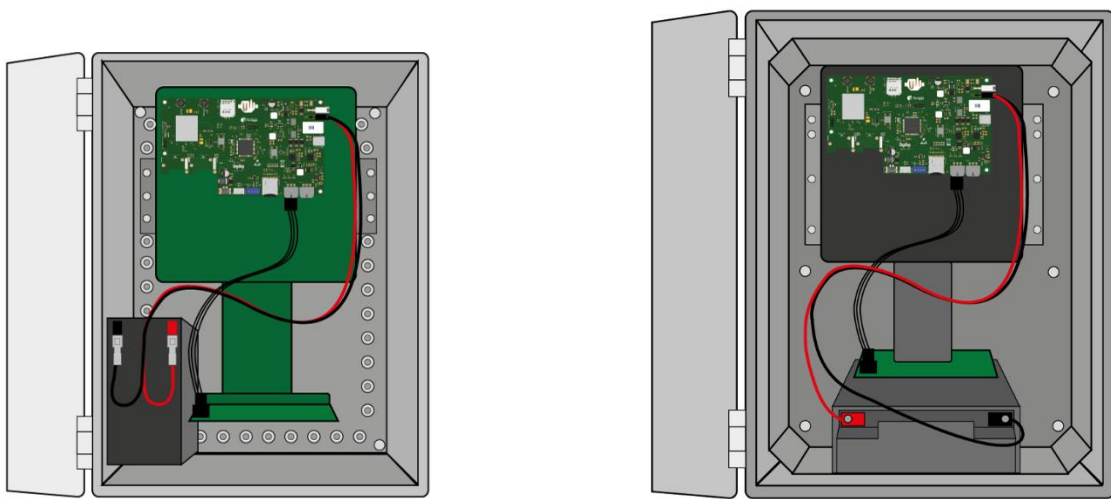

Figure 17: Finapp with 9Ah battery (left) and Finapp Plus with 18Ah battery (right)

5.7 Connect battery and solar panel

Solar panel and battery cable are pre-wired. Connect the black male MOLEX from battery to the female black MOLEX in the board (connector 2, figure 3), repeat for white connector of the solar panel (connector 1, figure 3).

5.8 Switch ON the system

Now, you are ready to power on the system. Use the switch (switch 6, figure 3) on the board to power on the system. The central LED (red square, figure 3) turns green and remains ON for a few seconds until the correct initialization of the board. To operate the system indoor, you can use the

USB-C female connector (connector 6, figure 3), the power requirement is 5V (1.5A).

When the board is turned on, the LED (red square, figure 3) lights up. The LED takes on different colors depending on the status of the board. If the probe is working properly, the LED takes on these colors:

Red → Green → LED off → Blue → LED off

After that, LED turn ON blue when the board is connecting to the Finapp server.

After observing that there are no problems with the LED lighting sequence, you can check the correct operation of the probe through the "Status Control Panel" (chapter 8.4).

In case there are problems with the LED color sequence, or the "Status Control Panel" gives a 'Not OK' status, please contact Finapp.

6. Finapp-SWE Installation Guide

In case you are installing the Finapp probe to measure SWE (Snow Water Equivalent), please follow these instructions:

6.1 Probe on the pole

The probe to be installed on the pole is the one containing the master board. To install this probe, follow the steps described in "Finapp Soil Moisture (SM) Installation Guide" up until step 6.

NOTE: Since the probe must always be above the snow surface, it needs to be installed higher than a Soil Moisture installation. The suggested height is between 3 to 5 meters.

6.2 Probe on the ground

The next step is to install the ground probe. The ground probe is the one in the aluminum box. It should be installed more than 3 meters away the

position of the pole. Install the box underground and with the lid protruding from the ground.

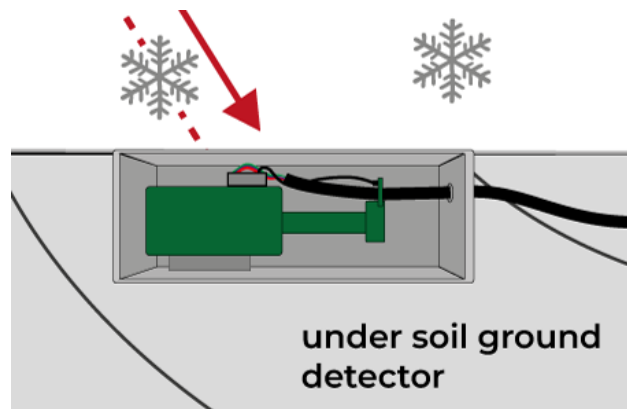

Figure 18: How to position the aluminum box

Alternatively (for example, in the case where the ground is rocky), you can fix the box to the ground surface and secure it with stakes.

6.3 Connecting the two probes

Use the provided 15 meters 6-pin cable to connect the two boxes. The cable is a 6-pin cable with wires of 1.5 mm of diameter and crimp connectors at the extremities.

Start from the box on the pole, insert the 6-pin cable on the terminal block as show in figure 19. Each number is matched with a color of the 6-pin cable wire.

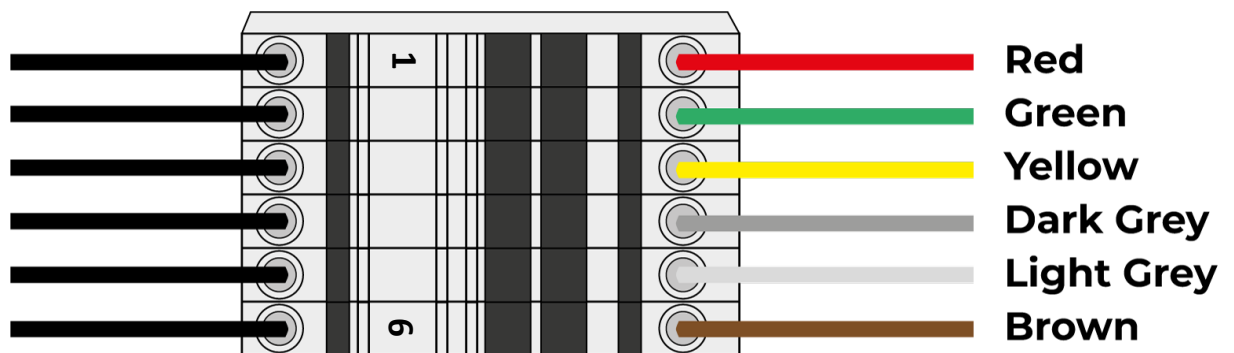

Figure 19: Terminal block for the 6-pin cable

This cable should exit from the bottom of the box through an IP68 cable gland. Repeat the operation also for the box installed on ground, keeping the same color-numeration wiring. The 6-pin cable provides both power and signal to this probe.

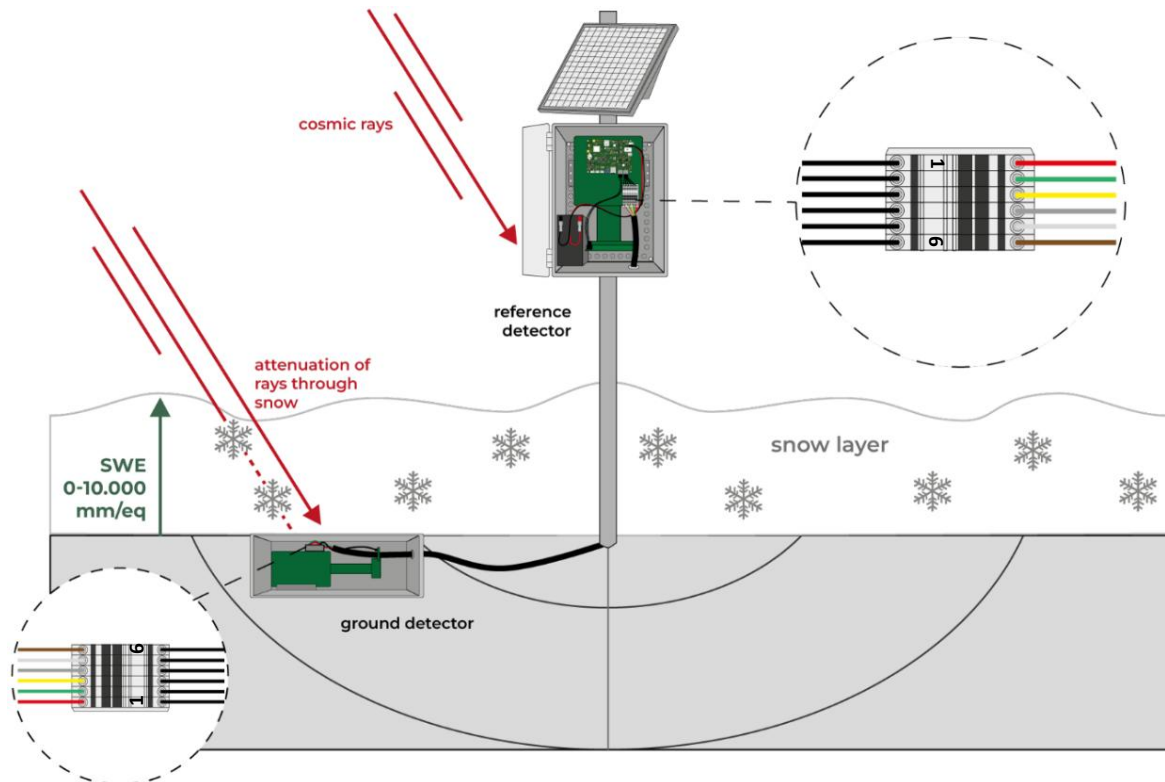

Figure 20: SWE installation with terminal blocks on both the probe

To the box on the ground, in addition to the IP68 cable gland, it is recommended to use silicone to further insulate the part of the gland where the cable comes out. Depending on the installation could be recommended to use a corrugated pipe to protect the 6-pin cable.

The box on the ground is made of die-cast aluminum and to preserve IP68 grade protection, it is recommended to tighten the screws in cross-like manner: insert all the screws into the cover at the same time, then tighten one screw by a couple of turns and then fasten the screw on the opposite side of one diagonal of the box by a couple of turns. Do the same for the other diagonal and then repeat the whole process again. Repeat the operation until all screws have been tightened well.

When you have successfully installed both probes, you can turn on the switch on the main board (follow chapter 5.8).

7. Deinstallation

If you need to move/dismount the system, please follow the steps below in order to not damage the Finapp system:

7.1 Safe power-off

open the box and use the switch to power off the probe (switch 5, figure 8).

7.2 Remove cables

disconnect the MOLEX of solar panel (connector 1, figure 8) and then the MOLEX of the battery (connector 1, figure 8). Disconnect temperature sensor (connector 4, figure 8) and remove it from the bottom of the box, the solar panel cable must be removed as well. **For Snow Water Equivalent installation:** remove the 6-pin cable that connects the two boxes.

7.3 Remove battery

Remove the battery.

7.4 Dismount hardware from the pole (and ground)

Now you are ready to dismount the system from the probe in safe way.

8. Finapp Cloud Platform

8.1 Access the Finapp Dashboard

The Finapp Dashboard will be your customized interface to access the data measured by your Finapp probes and processed by our Cloud. It is located at the link:

<https://cloud.finapptech.com/finapp/>

If you access the Dashboard for the first time, you will need to register.

You can do that by clicking on the provided link in the login page (marked by a red rectangle in the figure):

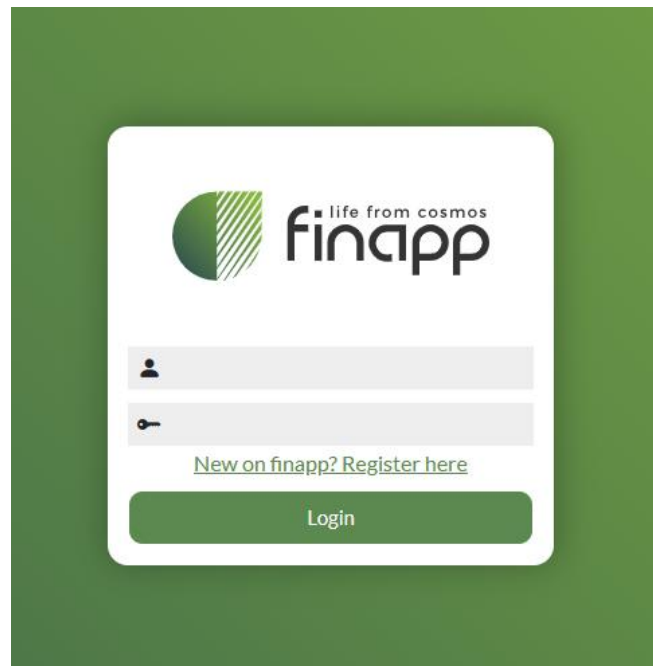

Figure 21: Login page on Finapp Cloud

Or you can go at the link:

<http://cloud.finapptech.com/finapp/registration.php>

Once you enter the registration module, you only need to insert a username, a password, and your email.

The username must be unique, and the password needs to have at least 8 characters, with an uppercase letter, a lowercase letter and a number, we recommend using a special symbol too, but it is not required.

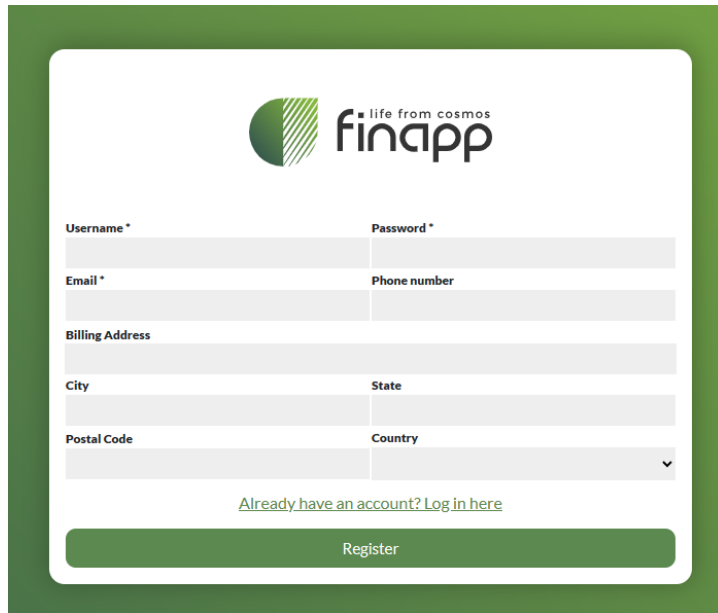

The registration page features the Finapp logo at the top, which includes a green circular icon with diagonal lines and the text "life from cosmos finapp". Below the logo is a registration form with the following fields: "Username *" and "Password *" (both required), "Email *" and "Phone number", "Billing Address", "City" and "State", "Postal Code" and "Country" (with a dropdown arrow). A link "Already have an account? Log in here" is positioned above a green "Register" button.

Figure 22: Registration page on Finapp Cloud

Once you registered successfully you can login.

If you need any assistance, contact info@finapptech.com.

8.2 Finapp Dashboard Configuration

Once logged in, you will see the list of Installations (Finapp probes) linked to your account. If you are connecting for the first time, it may be empty. In this case, click on “Add installation” button in the top-left corner of the screen.

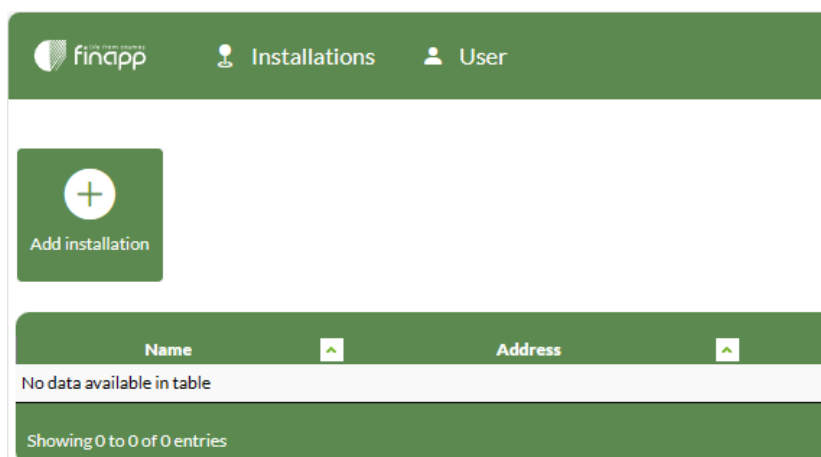

Figure 23: Add installation button

To add a new installation, you will need the Probe ID, that is found outside the delivery box and inside the door of the Finapp case, and the Installation Key, that will be found in a credential sheet inside the delivery box or provided by email. Click on the “Add installation” button and enter the required details.

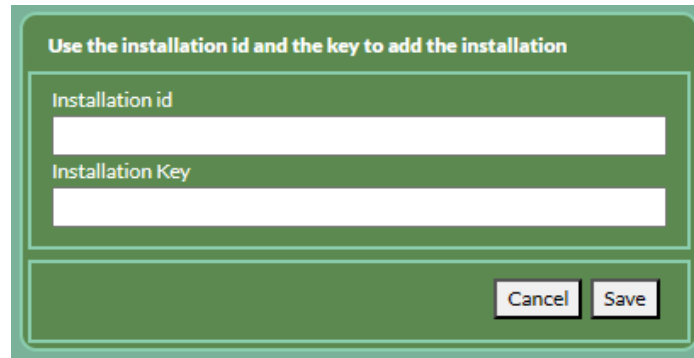

Figure 24: Where to insert the Installation ID and Installation Key

Any installation in the list can then be accessed by clicking on it. The first time you access an installation, it will require the configuration of a set of parameters that are required for the data elaboration.

Data will not be displayed until the required parameters are set.

Functional details to be provided are:

1. Installation date
2. Coordinates of the site (Latitude and Longitude of the site as you can extract from Google Maps or similar services)
3. Altitude of the site

The above information is due to be inserted in the “Meta Data” panel of the Graphical Interface, as detailed in Section 3 of the present manual.

When you turn on the probe for the first time, we will receive an automatic notification and will start the procedure to configure and activate the station. Data will be displayed within 1 to 2 working days from the activation of the probe, but they should not be considered final yet. We will perform a check and validation of the collected time series after at least 1 week and within 10 days. After the validation, the station is to be considered fully functional and the whole time series since the installation date will be available.

If you need any assistance, contact info@finapptech.com.

8.3 Data visualization

You can access any of your Installations by just clicking on its line in the installations list. At this point you will see the tabs where to visualize data from this installation, as follows.

The first tab is called “CHARTS”, and it is detailed in the figure below:



Figure 25: Soil moisture graphic on the “Charts” tab

You can navigate the available plot by the tabs, like “SOIL MOSTURE”, “SNOW WATER EQUIVALENT”, “WEATHER DATA”, “DIAGNOSTICS”, and see the graphical representation of the trend in time of the corresponding parameters. The list of available tabs and plots may vary depending on your service package and purchased equipment. The full list of data plots that may or may not be included is the following:

- Soil Moisture
- Snow Water Equivalent Areal (Neutrons above snow)
- Snow Water Equivalent Local (Neutrons below snow)
- Neutrons (pressure-corrected)
- Muons (pressure-corrected)
- Neutrons (incoming-corrected)
- Inside Temperature

- Atmospheric pressure
- Outside Temperature
- Relative humidity
- Neutron raw counts
- Muon raw counts
- Gamma raw counts
- Battery voltage

Meteorological data like temperature, pressure and humidity can be found in the “WEATHER DATA” tab. Battery voltage is found in the “DIAGNOSTICS” tab as the most useful parameter to check that the power supply is good.

If more time series are shown in the same graph, it is possible to hide the data by clicking the data label in the legend. By re-clicking above, the hidden time series is reactivated.

The buttons below the figure allow you to reset the zoom, open the figure in full screen, download the figure, or download the data shown in the figure in CSV format. By hovering with the mouse on a plot, it is possible to zoom in/out the areas of interest. For a more accurate selection of the time interval of interest, it is possible to set a specific starting and ending date and time by selecting them on the calendars and then click the Update button.

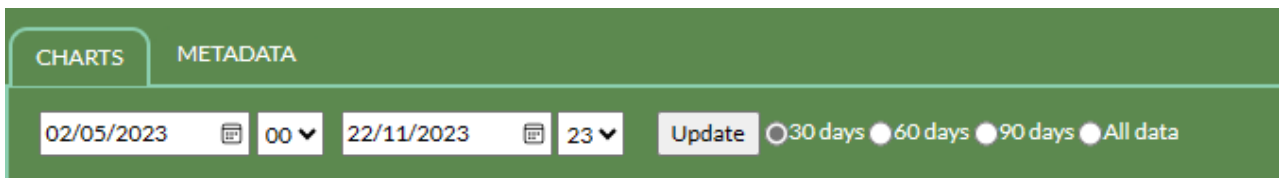

Figure 26: Detail on the time interval selection for the Charts' data

The buttons on the right are used to set the length of the showed time series in the plot: it can be set to last 30 days, last 60 days, last 90 days or the whole available series (“All data”).

The other tab of the primary group is called "META DATA". It contains geographical data and the type of installation. Please fill the editable fields with information about coordinates, installation date, altitude and time zone of your station. **Some plots may not be displayed until the Meta Data are inserted.**

8.4 Status control panel

Using the following link, you can access the installation status control page:

<http://cloud.finapptech.com/finapp/wtcd/>

Once you open this page, there will be a single input requested: the installation ID. It will generate a page with some Status information.

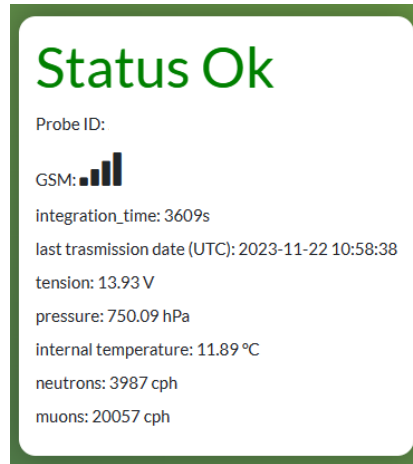

Figure 27: Status information on the status control panel

The status “OK” or “NOT OK” depends on some control parameters including the last transmission date and the counts of muons and neutrons.

If the status is NOT OK, please contact info@finapptech.com for assistance.

9. Data transfer

9.1 Download data from API

It is possible to retrieve real-time data from the Finapp CLOUD using our API.

The base link to the API is:

http://cloud.finapptech.com/finapp/api/v2/getCSV_id.php?ID=XX&D=1&token=XX

The API link requires the following settings:

- “ID=xx” requires the probe ID, that is the number identifying the main board and related installation. On the back of your User Credentials sheet, you can find a table listing all the IDs associated to your User Account.
- Detector number (D) that identifies which detector to download the data from.

- &D=1, Neutron detector
- &D=2, Cosmic-ray monitor and Gamma detector (optional)
- “&token=XX” requires the key to access the API that Finapp will provide you.

In addition to these parameters, the following options can be added at the end:

- &L=1 if you wish to download the most recent data point only
- &SM=1 If I want the neutron counts to be converted to soil moisture (optional)
- &SWE=1 If I want the neutron counts to be converted to snow water equivalent (optional)
- &START=YYYYMMDD end &STOP=YYYYMMDD if I want to select only a part of the time series. If &START=YYYYMMDD is omitted, the time series starts from the oldest data available. If &STOP=YYYYMMDD is omitted, the time series ends with the latest data available.

The file shows the following information printed in columns, separated by semicolons:

- Time stamp (UTC)
- Counts per interval of each particle (neutron, muon, gamma)
- Integration time (in seconds)
- Atmospheric Pressure (hPa)
- Inside temperature (°C)
- Outside temperature (°C)
- Outside Humidity (%)
- Input voltage (V)

If &SM=1 or &SWE=1 is selected, the neutrons, muons and gamma counts are not reported, being replaced by the value of soil moisture [g/g] or snow water equivalent [mm], respectively. **N.B.** particle counts in the API are NOT CORRECTED by pressure or incoming, they are raw particle counts from the detectors.

The output appears as in the following example:

```
#Datetime;neutrons;muons;gamma;integration_time(s);V_in(Volt);temperature_i
n(°C);temperature_ext(°C);ur(%);pressure(hPa);
```

```
2021-05-28 16:39:51;645;5671;0;3600;14.4;32.5;25.6;31.6;1017.8;
```

9.2 Retrieve data on SD Card

In addition to the API, there are 2 other ways through which data can be obtained:

- Printed on SD at address: SD:/LOG inside the file named after the date on which the data was acquired. In this case the data is formatted in this way:

Index	Parameter	Unit
1	IMEI	--
2	Pmt Board number	--
3	UTC date & Time	yyyyMMddhh mmss.sss
4	Pressure	Pa
5	Temperature on Board	Degrees
6	External Temperature	Degrees
7	External Relative Humidity	%
8	Battery Voltage	Volt
9	Acquisition Time	ms
10	Neutrons	--
11	Muons	--

NOTE: this feature is active only when requested by the client, and it's not active by default.

9.3 GPS data

The probe can be equipped with a GPS for a rover use. The GPS model is the SIMCOM868. The integration time for GPS is fixed at 1 second. Aggregation at greater intervals can be done offline by software. The data are stored locally on an additional SD card, that can be easily removed. The output format of the Finapp probe is as follow:

=====

+CGNSINF:

1,1,20220316153123.000,46.865349,11.041909,211.774,2.20,265.2,1,,2
.6,2.8,1.0,,5,4,,,38,

Moisture=-2147483648;

Pressure=81078;

Temperature_int=12800;

Temperature_ext=-2147483648;

Slave:1;N=90;M=5

Slave:4;N=0;M=97

=====

The +CGNSINF is formatted as follow:

Index	Parameter	Unit	Range	Length
1	GPS	--	0: Disable – 1:Enable	1
2	Fix status	--	0: Disable – 1:Enable	1
3	UTC date & Time	yyyyMMddh h mmss.sss	yyyy: [1980,2039] MM : [1,12] dd: [1,31] hh: [0,23] mm: [0,59] ss.sss:[0.000,60.999]	18
4	Latitude	±dd.ddddd d	[-90.000000,90.000000]	10
5	Longitude	±ddd.dddd dd	[-180.000000,180.000000]	11
6	MSL Altitude	Meters		8
7	Speed Over Ground	Km/hour	[0,999.99]	6
8	Course Over Ground	Degrees	[0,360.00]	6
9	Fix Mode	--	0,1,2	1
10	Reserved1			0
11	HDOP	--	[0,99.9]	4
12	PDOP	--	[0,99.9]	4
13	VDOP	--	[0,99.9]	4
14	Reserved2			0
15	GPS Satellites in Vies	--	[0,99]	2
16	GNSS Satellites Used	--	[0,99]	2
17	GLONASS Satellites in View	--	[0,99]	2
18	Reserved3			0

19	C/NO max	dBHz	[0,55]	2
20	HPA	Meters	[0,9999.9]	6
21	VPA	Meters	[0,9999.9]	6

The other lines contain:

Moisture -> The Relative Humidity from external sensor in milli%. Default value with no sensor present: -2147483648;

Pressure -> Atmospheric Pressure in Pa

Temperature_int -> Temperature inside the box in milliCelsius

Temperature_ext -> Outside temperature in milliCelsius. Default value with no sensor present: -2147483648;

Slave -> The first number identifies detector number (1,3 muon/neutron and 2,4 gamma/muons). N means neutron counts and M means muon counts.

N.B. The particles counter is not reset every second, but it integrates the value until 1h, when the counts are transmitted to the CLOUD as in normal probe operation.

10. External Modules

10.1 SDI-12

In case SDI12 protocol is to be used, an additional module will be provided to be connected to the master board.

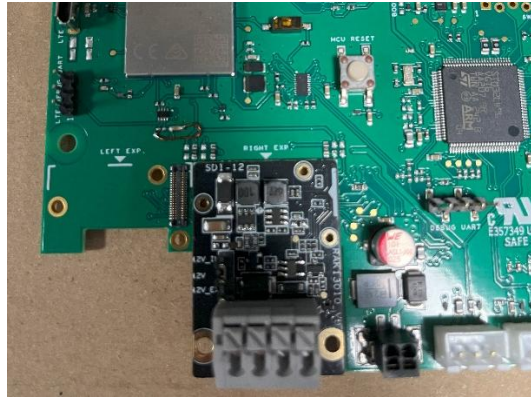

Figure 28: SDI12 Module

SDI12 module connection

You can connect the external data logger to the module following the instructions in figure 29. In case you need additional information about the SDI12 module, you can find the module data sheet at the following link:

[RAK13010 WisBlock SDI-12 Module Datasheet | RAKwireless Documentation Center](#)

WARNING: the master board will be powered with the SDI12 module power supply. To avoid any malfunction, please do not attach other power supplies from the main board (battery or solar panel).

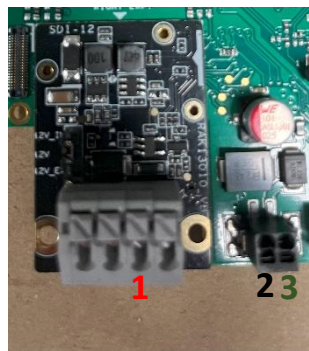

Figure 29: SDI12 module to data logger connections: 1 - DATA, 2 - GND, 3 – 12V

If you would like to use the battery and solar panel to give power supply to the board, you can connect the datalogger like described in figure 30.

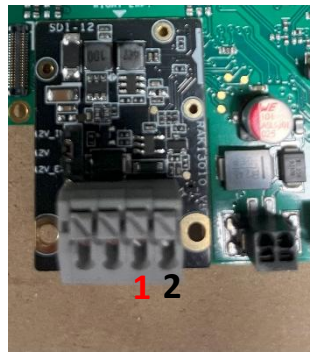

Figure 30: SDI12 module to data logger connections: 1 - DATA, 2 - GND

SDI12 data retrieval

The default address can be changed only by producer. If you need different address, please ask to Finapp personnel.

Command description *Command* *Probe answer*

Send Identification a! Allccccccmmmmmmvwx...xxx<CR><LF>

A	sensor address [default "F"]
Ll	SDI version [default "14"]
ccccccc	vendor [default "Finappl"]
mmmmmm	model [default "Fprobe"]
Vwv	major firmware version [default "003"]
xxx...xxx	last 13 chars of the IMEI address

Master Information

Master information are data measured by the MASTER board, refers mainly to atmospheric data and the status of the battery.

Command description *Command* *Probe answer*

Master Information aM! atttn<CR><LF>

A	sensor address [default "F"]
Ttt	time to have the data ready [default "1"s]

N	number of measurements [currently "6"]
---	--

Command description *Command* *Probe answer*

Master Data aD0! a<values><CR><LF>

a	sensor address [default "F"]
<values>	1) measurement progressive counter
	2) battery voltage [mV]
	3) pressure [Pa]
	4) temperature on board [m°C]
	5) external temperature (optional SHT20)
	6) external air humidity (optional SHT20) [mRH]

Finapp sensor Information

This command retrieves raw data from different Finapp sensors used in the same installations. N refers to the Finapp ID (N = 1,2,3,4 = Finapp ID), the number of Finapp installed depends on application. Typically, one Finapp is used for soil moisture applications or 2 Finapp are used for SWE applications.

Command description *Command* *Probe answer*

Finapp Information aMN! attn<CR><LF>

a	sensor address [default "F"]
ttn	time to have the data ready [default "1" s]
n	number of measurements [currently "5"]

Command description *Command* *Probe answer*

Finapp Data aD0! a<values><CR><LF>

a	sensor address [default "F"]
<values>	1) measurement progressive counter
	2) HV voltage [mV] ! NOT CALIBRATED
	3) acquisition time [ms]
	4) number of neutrons

	5) number of muons
--	--------------------

Elaborated Data

This command returns the elaborated data from the Finapp sensors (Soil Moisture or Snow Water Equivalent).

N.B. By default the soil moisture is gravimetric (g/g), if the bulk density is provided the output will be Volumetric (m³/m³).

<i>Command description</i>	<i>Command</i>	<i>Probe answer</i>
Water measurements	aM5!	atttn<CR><LF>

a	sensor address [default "F"]
ttt	time to have the data ready [default "1" s]
n	number of measurements [currently "3"]

<i>Command description</i>	<i>Command</i>	<i>Probe answer</i>
Water Data	aD0!	a<values><CR><LF>

a	sensor address [default "F"]
<values>	1) measurement progressive counter
	2) soil moisture [fraction*1000] (123 = 12.3%)
	3) SWE Areal [mm*10] (123 = 12.3 mm)
	4) SWE Local [mm*10] (123 = 12.3 mm)
	5) SWE Backup [mm*10] (123 = 12.3 mm)

WARNING: the measurement progressive counter changes when new measurements are available. Reading with the same counter will be just repeated readings.